

**PNEUMATIC CONTROL VALVES  
PV253G  
(V253G globe valves series with linear actuators PA series)**

**DESCRIPTION**

The PV253G control valves are three-way valve body both for mixing or diverting service. The PA pneumatic actuator has rubber diaphragm and multi-springs. Its action can be DA – direct action (air to close) or RA – reverse action (air to open). The PV253G valves have been designed to ensure an accurate control in any process condition. Their wide application ranges allow the use of this valve with the most common process fluids such as water, superheated water, diathermic oil, steam, air, gas and other non corrosive fluids.

**MAIN FEATURES**

Mixing or diverting purpose control valve.  
Standard packing or bellows sealed stem sealing.

**OPTIONS:** Position transmitter 4-20 mA.  
Pneumatic or electropneumatic positioner.  
Air filter regulator.  
Top-work manual handwheel.

**USE:** Hot and superheated water.  
Diathermic oil.  
Saturated and superheated steam.  
Air, gases and other noncorrosive fluids.

**AVAILABLE MODELS:** PV253G.

**VALVE SIZES:** DN 15 to DN 150.

**CONNECTION:** Flanged EN 1092-2.

**PNEUMATIC ACTUATORS:** PA series.

**ACTUATOR CONN.:** 1/4" NPT-F.

**CONTROL SIGNAL:** 0,2 – 1bar; 0,4 – 1,2 bar; 0,4 – 2 bar.



**MAX.AIR SUPPLY:** 3,5 bar.  
**AMBIENT TEMPERATURE:** -20 °C to 70 °C.  
**STEM SEALING:** PTFE/GR V-Rings – up to 220°C.  
Stainless steel bellows.  
**PLUG CHARACTER.:** PL – Linear;  
**PORT:** Full port.  
**ELECTRIC ACT.:** Consult catalog IS EL20.00 E.

**HOW TO SELECT:** Never size the valve according to the pipe diameter in which it has to be fitted, but according to the required actual flow of steam or water. Refer to valve calculation data sheet or consult the factory.

CE MARKING – GROUP 2 (PED – European Directive)		
PN16	PN25	Category
DN 15 to DN 50	DN 15 to DN 40	SEP
DN 65 to DN 150	DN 50 to DN 125	1 (CE marked)
–	DN 150	2 (CE marked)

BODY LIMITING CONDITIONS					
V – RINGS PACKING			BELLWS SEALED		
ALLOWABLE PRESSURES		RELATED TEMP.	ALLOWABLE PRESSURES		RELATED TEMP.
PN16	PN25		PN16	PN25	
16 bar	25 bar	-10 °C/120 °C	16 bar	25 bar	-10 °C/120 °C
15,5 bar	24,3 bar	150 °C	15,5 bar	24,3 bar	150 °C
14,7 bar	23 bar	200 °C	14,7 bar	23 bar	200 °C
14,3 bar	22,5 bar	220 °C	13,9 bar	21,8 bar	250 °C
–	–	–	12,8 bar	20 bar	300 °C
–	–	–	11,2 bar	17,5 bar	350 °C

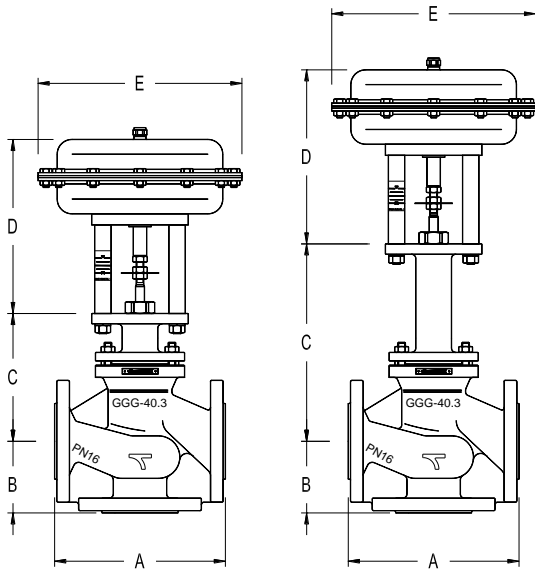

V-Rings packing valve

Bellows sealing valve

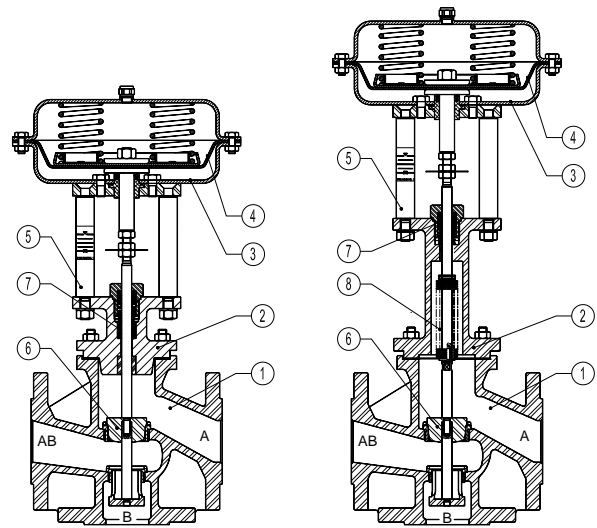

V-Rings packing valve

Bellows sealing valve

DIMENSIONS - VALVE BODY						
SIZE DN	A (mm)	B (mm)	BONNET			
			STANDARD PACKING		BELLOWS SEALING	
			C (mm)	WGT. (kg)	C (mm)	WGT. (kg)
15	130	65	143	8	265,5	10
20	150	70	157	9	279,5	11
25	160	75	151	10	273,5	11,5
32	180	80	158	12,5	280,5	14,5
40	200	90	163	14	285,5	16
50	230	100	166	16	288,5	19
65	290	120	209	32	418,5	36
80	310	130	209	36	418,5	40
100	350	150	217	51	426,5	54
125	400	200	319	107	529	95
150	480	210	334	130	544	125

MATERIALS		
POS. Nº	DESIGNATION	MATERIAL
1	Valve body	GJS-400-18-LT / 0.7043
2	Bonnet	GJS-400-18-LT / 0.7043
3	Actuator (steel)	S235JRG2 / 1.0038
	Actuator (st. steel)	AISI 304 / 1.4301
4	Diaphragm	NBR70
5	Yoke (steel)	C45E / 1.1191
	Yoke (st. steel)	AISI 304 / 1.4301
6	Valve plug	AISI 316 / 1.4401
7	Safety packing	PTFE/GR
8	Bellows	Stainless steel

DIMENSIONS PNEUMATIC ACTUATOR			
TYPE	E (mm)	D (mm)	WEIGHT (kg)
PA205	210	235	6
PA280	275	245	10
PA340	335	265	15
PA435	430	295	25

FAILURE POSITION DEPENDING ON VALVE DUTY			
Mixing valve		Diverting valve	
Dir. action actuator a)	Rev. action actuator b)	Dir. action actuator a)	Rev. action actuator b)
Port A to AB closes	Port B to AB closes	Port AB to B closes	Port AB to A closes

- a) Retracted stem on air failure.
- b) Extended stem on air failure.

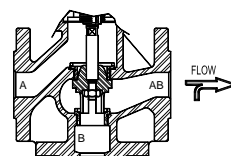

Mixing valve

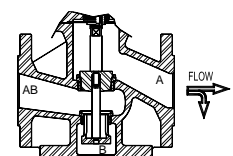

Diverting valve (Only DN40 and above)

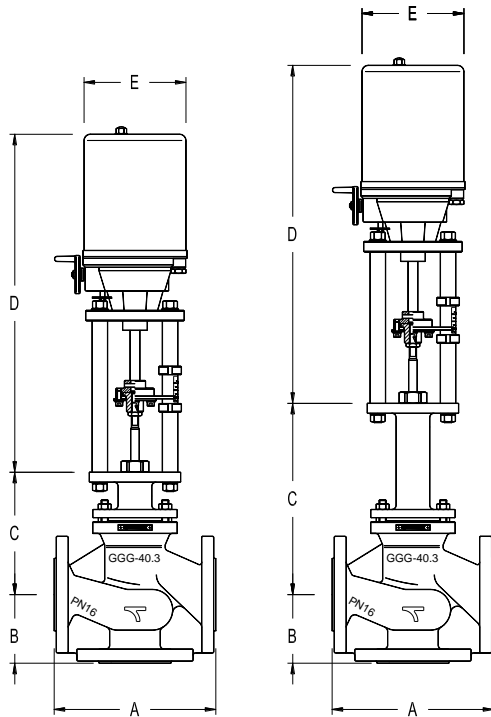

V-Rings Packing valve

Bellows sealed valve

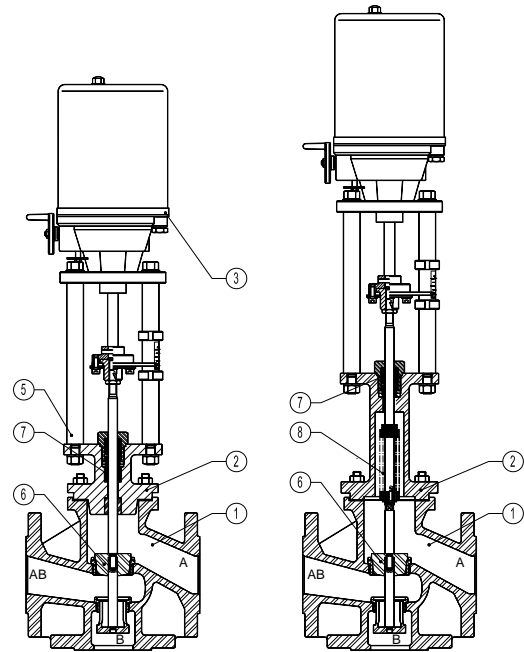

V-Rings Packing valve

Bellow sealed valve

DIMENSIONS – VALVE BODY						
SIZE DN	A (mm)	B (mm)	BONNET			
			STAND. PACKING		BELLOWS SEALING	
			C (mm)	WGT. (kg)	C (mm)	WGT. (kg)
15	130	65	143	8	265,5	10
20	150	70	157	9	279,5	11
25	160	75	151	10	273,5	11,5
32	180	80	158	12,5	280,5	14,5
40	200	90	163	14	285,5	16
50	230	100	166	16	288,5	19
65	290	120	209	32	418,5	36
80	310	130	209	36	418,5	40
100	350	150	217	51	426,5	54
125	400	200	319	107	529	95
150	480	210	334	130	544	125

MATERIALS		
POS. N°	DESIGNATION	MATERIAL
1	Valve body	GJS-400-18-LT / 0.7043
2	Bonnet	GJS-400-18-LT / 0.7043
3	Actuator casing	Aluminium
5	Yoke (steel)	C45E / 1.1191
6	Valve plug	AISI 316 / 1.4401
7	Safety packing	PTFE/GR
8	Bellows	Stainless steel

DIMENSIONS ELECTRIC ACTUATOR			
TYPE	E (mm)	D (mm)	WEIGHT (kg)
EL-12	130	340	2,1
EL-20	145	458	8
EL-45	145	458	8
EL-80	188	517	13
EL-120	188	517	13

**MAX. PERM. PRESSURE DROP (bar) – N.C. (fluid to open) – Reverse or direct action actuator**

ACTUATOR	CONTROL SIGNAL	SIZES								
		DN 15	DN 20	DN 25	DN 32	DN 40	DN 50	DN 65	DN 80	DN 100
PA205	0,2 ÷ 1 bar	6	6	5	–	–	–	–	–	–
	0,4 ÷ 1,2 bar	10	10	7	–	–	–	–	–	–
	0,4 ÷ 2 bar	12	12	9	–	–	–	–	–	–
PA280	0,2 ÷ 1 bar	28	26	16	8	6	3,5	–	–	–
	0,4 ÷ 1,2 bar	40	38	20	12	10	5	–	–	–
	0,4 ÷ 2 bar	50	45	25	16	12	6,5	–	–	–
PA340A	0,2 ÷ 1 bar	60	60	50	20	12	10	–	–	–
	0,4 ÷ 1,2 bar	80	80	60	30	16	13	–	–	–
	0,4 ÷ 2 bar	100	100	80	40	20	18	–	–	–
PA340B	0,2 ÷ 1 bar	–	–	–	–	–	–	4	2,5	1
	0,4 ÷ 1,2 bar	–	–	–	–	–	–	5	3,5	1,5
	0,4 ÷ 2 bar	–	–	–	–	–	–	6	4	2
PA435A	0,2 ÷ 1 bar	–	–	–	–	40	25	–	–	–
	0,4 ÷ 1,2 bar	–	–	–	–	48	30	–	–	–
	0,4 ÷ 2 bar	–	–	–	–	55	45	–	–	–
PA435B	0,2 ÷ 1 bar	–	–	–	–	–	–	6	5	3
	0,4 ÷ 1,2 bar	–	–	–	–	–	–	8	7	5
	0,4 ÷ 2 bar	–	–	–	–	–	–	10	8	6

For valve size DN 125 and above, consult factory.

The pressure drop values refer to closed valves. They have been verified by a control signal coming from an electro-pneumatic converter with an enduring minimum signal of 0,2 bar.

The actuator pressure drops given with closed valve for the actuator signal 0,4 - 2 bar are also valid for ON-OFF service with air supply at 2,4 bar.

Special spring drops available on request.

The pressure drop values must be used within the body rating limits.

For electric actuator selection please consult catalogue IS EL 20.00 E or consult factory.

**FLOW RATE COEFFICIENTS**

	SIZES											
	DN 15	DN 20	DN 25	DN 32	DN 40	DN 50	DN 65	DN 80	DN 100	DN 125	DN 150	DN 200
<b>Kvs</b>	4	6,3	10	16	25	40	63	100	160	230	330	–

Kvs in m<sup>3</sup>/h, see IS PV10.00 E;

For conversion Kvs = Cv (US) x 0,855.

**VALVE STROKE (mm)**

	SIZES											
	DN 15	DN 20	DN 25	DN 32	DN 40	DN 50	DN 65	DN 80	DN 100	DN 125	DN 150	DN 200
<b>STROKE</b>	20	20	20	20	20	20	30	30	30	35	40	–

ORDERING CODES V253										
VALVE CODES		V	.23G	M	1	7	L	15	.X.	E
Actuator type (1)										
Pneumatic actuator		P								
Electric actuator		E								
Group designation										
Globe valve, three way		V								
Valve model										
GJS-400-18-LT body			.23G							
Flow										
Mixing				M						
Diverting (only available for DN 32 and above)				D						
Stem sealing										
PTFE/GR-V-Rings / Standard bonnet									1	
Virgin PTFE V-Rings / Standard bonnet									2	
Graphite / Standard bonnet									3	
Stainless steel bellows									8	
Valve plug										
PL (linear) – Metal AISI 316 / 1.4401									7	
Pipe connection										
Flanged EN 1092-1 PN16										L
Flanged EN 1092-1 PN25										M
Size										
DN 15										15
DN 20										20
...										
Actuator										(1)
Extras										
Full description or additional codes have to be added in case of non-standard combination										E

ACTUATOR CODES (pneumatic) *	P.	5	R	18
Group designation				
Multi-spring, pneumatic linear actuator	P.			
Actuator size				
205		1		
280		3		
340A – From DN 15 to DN 50		5		
340B – From DN 65 to DN 100		6		
435A – From DN 15 to DN 50		7		
435B – From DN 65 to DN 100		8		
Actuator type				
Direct action (air to close)			D	
Reverse action (air to open)			R	
Actuator Construction				
Steel construction (painted) – standard				(2)
Stainless steel construction				I
Control signal				
0,2 – 1 bar (3/15 psi)				15
0,4 – 1,2 bar (6/18 psi)				18
0,4 – 2 bar (6/30 psi)				30
0,4 – 2,4 (6/35 psi)				35

→ To be introduced on ".X.", if supplied in combination with the valve.

Example:

V235G mixing valve model, rating PN16, PL metal plug, PTFE/GR stem sealing, DN 50, complete with reverse action actuator signal 0,4 – 1,2 bar, size 340A , standard steel construction:

Code: PV.23G.M17L50.5R18

REMARKS:

- (1) – Indicate actuator type.
- (2) – Omitted if the standard actuator is selected.

DN 150 and DN 200 valves with bellows are not available as PN25.

ADCATrol control valves are identified by a serial number on a nameplate, located on the actuator yoke. When ordering spares, always use that serial number. If the valve has non-standard extras the serial number also has an E (extras).

\* For electric actuator ordering codes, consult our technical department